A2

2019.03

-\$ <

..... 1

..... 2

..... 3

..... 5

..... 6

..... 8

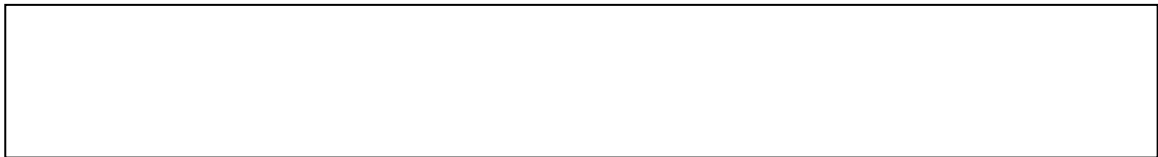

1.1 1 4

2

3

4 4

5

2

1.2 1 4

2

3

4 4

5

6 4

5

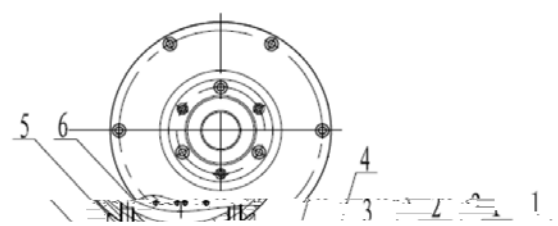
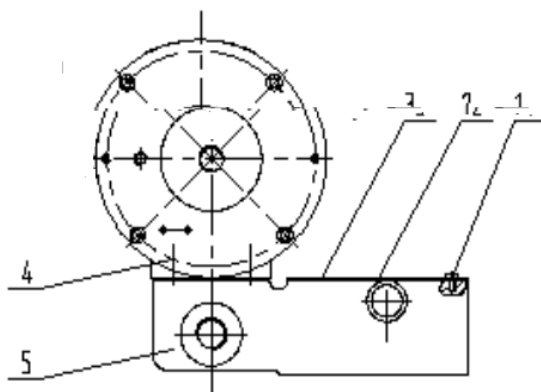

1.1

1.2

3

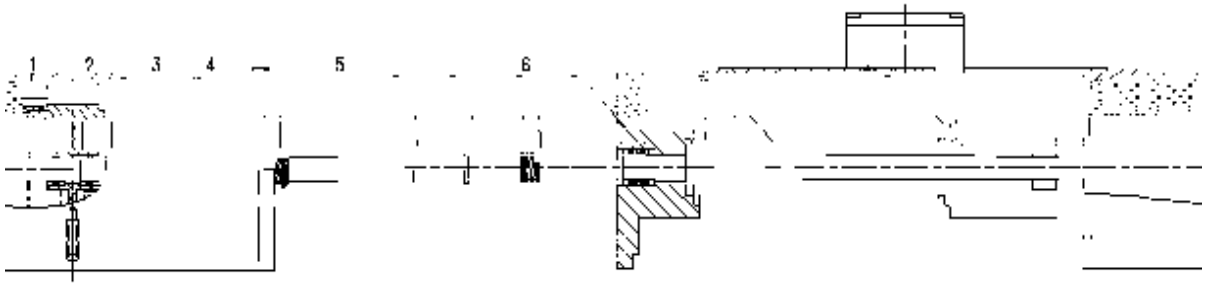

1.3

1.3

1

2

3

4

6

5

6

4

1

2

1.4

0.5mm

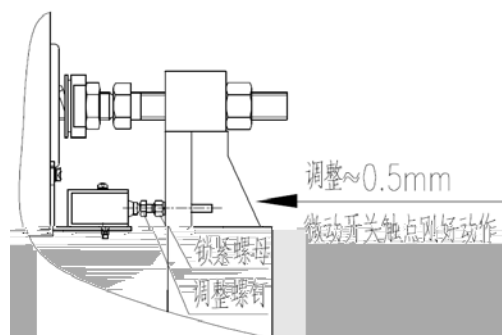

1.4

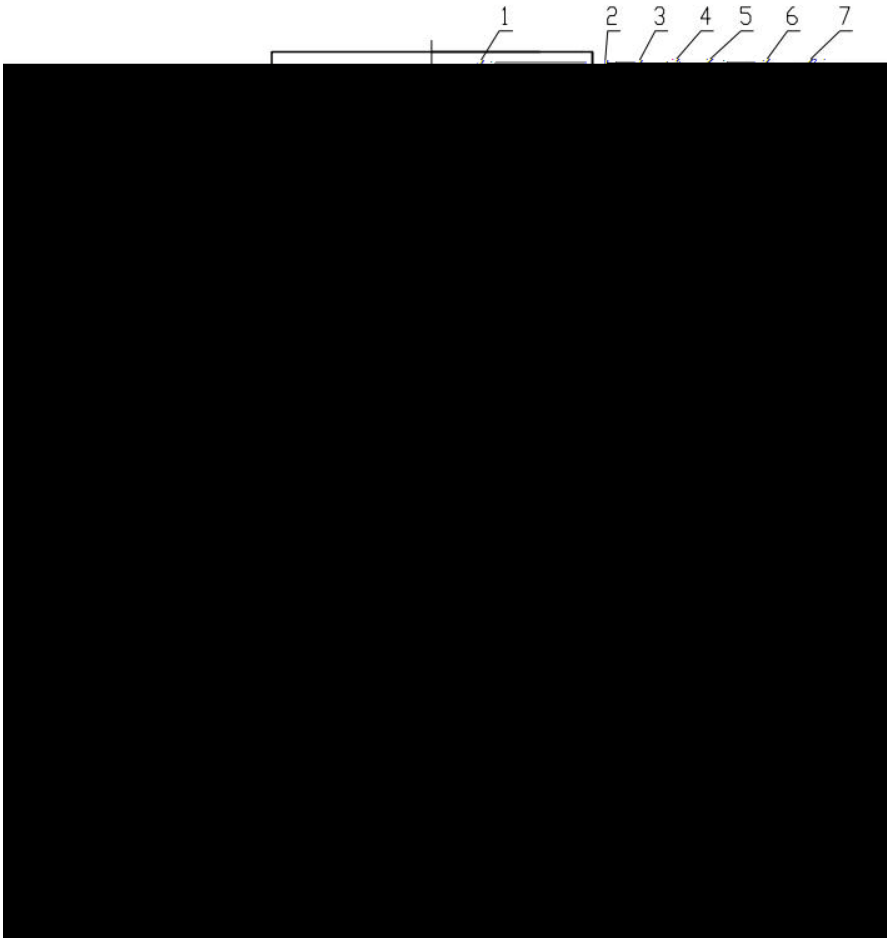

1

2

3

4

6mm

1.6

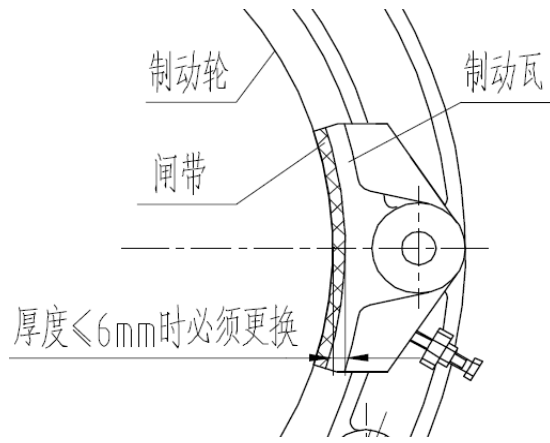

1.6

1

1.7

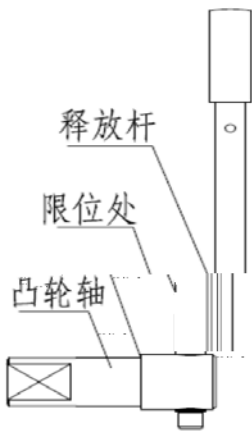

1.7

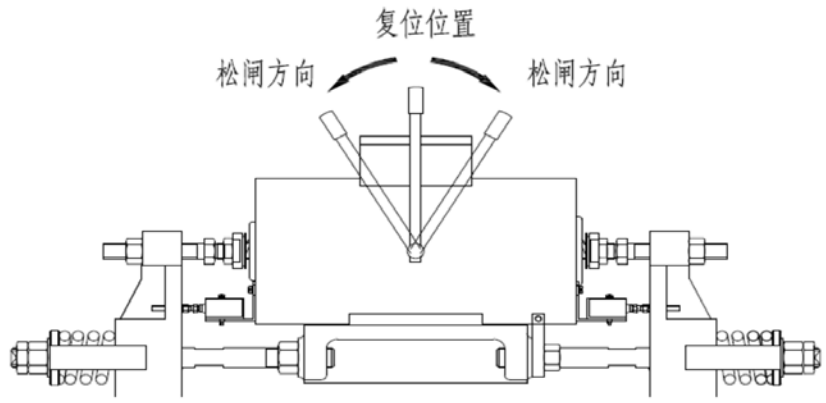

1.8

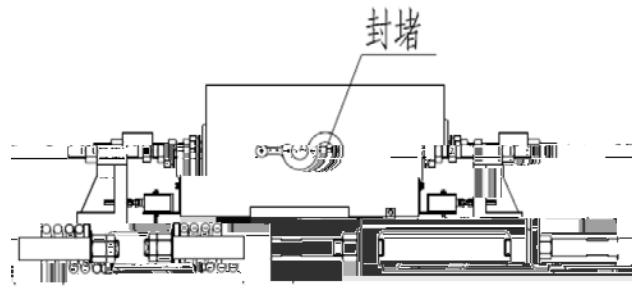

1.9

2

2.0

1

2

250mm

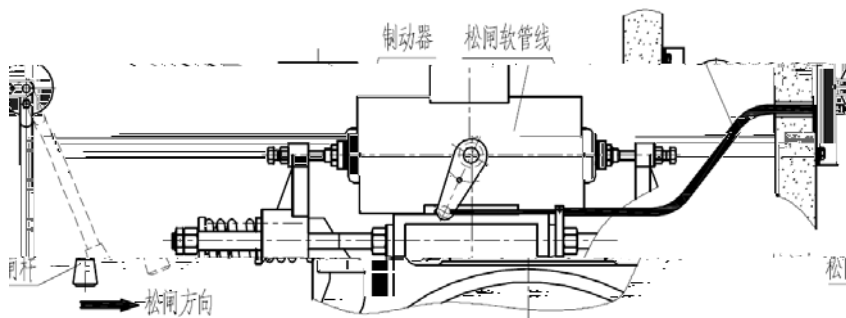

2.0

1

2

3

4

1.9

5

6

7